



TABLE OF CONTENTS

WILL FIT ALL 2017 AND UP; **MZ, ZT, Maverick, and Magnum models.**

SAFETY RULES AND INFORMATION.....	2
GENERAL OPERATION.....	3
WARRANTY INFORMATION.....	5
INSTALLATION INSTRUCTIONS.....	6





SAFETY RULES & INFORMATION



Read these safety rules and follow them closely. Failure to obey these rules could result in loss of control of unit, severe personal injury or death to you, or bystanders, or damage to property or equipment.
This mowing deck is capable of amputating hands and feet and throwing objects. The triangle in text signifies important cautions or warnings which must be followed.

⚠ GENERAL WARNINGS

<ul style="list-style-type: none"> • Know the mower controls, safety rules and how to stop quickly. READ AND UNDERSTAND THE MOWER OPERATOR'S MANUAL. • Read and obey all safety decals. • Wear appropriate ear, eye and breathing protection. • Only allow responsible adults, who are familiar with the instructions, to operate the unit. • Disengage the electric clutch (PTO). Shut off the engine and wait for all moving parts to stop before attaching, adjusting, or disconnecting any part of the collection system. • Check the collection system to make sure it is bolted tightly to the Mower. • DO NOT operate the mower without either the entire grass catcher or the deflector in place. • Turn off the PTO switch to disengage the blades when not mowing. • DO NOT mow in reverse. Always look down and behind before and while traveling in reverse. • DO NOT turn sharply when traveling alongside a building or any object. Slow down before turning. • DO NOT carry passengers on the rider. • When blower assembly is removed from the mower deck, the discharge chute must be properly installed. 	<ul style="list-style-type: none"> • Collector bags are subject to deterioration and wear during normal use. Inspect the bag periodically for tears, holes or weak spots and replace with a new bag that meets manufacturer's durability standards. • If the mower stalls or blower chute plugs: <ol style="list-style-type: none"> 1. Disengage the electric clutch (PTO); 2. Stop the engine and remove the key; 3. Set the parking brake, and wait for all moving parts to stop. 4. Remove the foreign object or clear the chute with a piece of wood before restarting the engine. NEVER place hands into blower housing to clear jammed object. Blower may rotate when object is removed. • For added rider stability and to prevent tipping or loss of control: <ol style="list-style-type: none"> a. Use reduced speed on uneven ground and when turning corners. b. Reduce loads on hillsides. It is recommended that the collection system be kept no more than half full when negotiating any slopes. Start mowing on slopes when the collection system is empty. c. Mow across the face of slopes: not up and down. d. If provided counter weights must be properly installed prior to using the grass collection system.
---	--

- **Never operate on slopes greater than 17.6% (10°).**

INSTALLATION INSTRUCTIONS: Bad Boy Grass Bagging System



SAFETY DECALS

This unit has been designed and manufactured to provide you with the safety and reliability.

Although reading this manual and the safety instructions it contains will provide you with the necessary basic knowledge to operate this equipment safely and effectively, we have placed several safety labels on the unit to remind you of this important information while you are operating your unit.

All DANGER, WARNING, CAUTION and instructional messages on your bagger should be carefully read and obeyed. Personal bodily injury can result when these instructions are not followed. The information is for your safety and it is important! The safety decals below are on your bagger.

If any of these decals are lost or damaged, replace them at once. See your local dealer for replacements.

These labels are easily applied and will act as a constant visual reminder to you, and others who may use the equipment, to follow the safety instructions necessary for safe, effective operation.

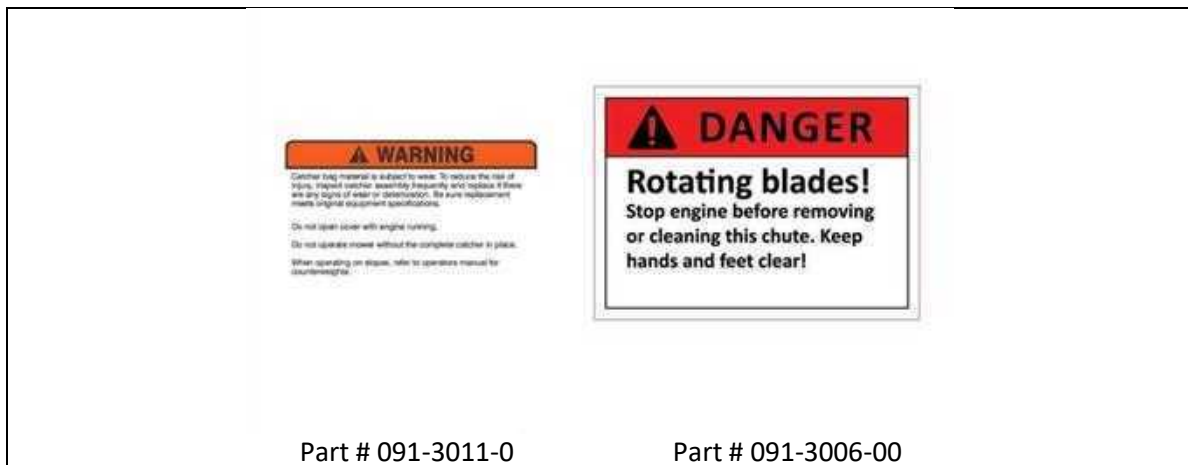

GENERAL OPERATING INSTRUCTIONS

BEFORE OPERATION

Clear the lawn of all sticks, stones, wire and other debris which may be caught or thrown by the mower blades.

Check grass condition. If wet, wait until later in the day. If grass is wet, the grass catcher is likely to become plugged.

For efficient bagging, air circulation under the mower deck, through the chute and into the bag is very important.

For this reason, BEFORE YOU BEGIN MOWING you should make certain the underside of the mower and the underside of the catcher lid are free from grass and debris.

Make sure that there is a snug fit between mower deck, blower housing, tubes, and grass catcher cover.

INSTALLATION INSTRUCTIONS: Bad Boy Grass Bagging System



MOWING WITH YOUR BAGGER

Always operate at maximum RPM while mowing.

Always wear hearing protection when operating grass catcher.

Grass should be cut often, and not too short. If grass is too long or lush it may be necessary to keep ground speed to a minimum or to cut only half the width of the mower to prevent clogging. If grass is long, operate with mower in high cutting position for first pass, cutting again in a lower position on a second pass.

Do not open the cover with mower engaged.

If a large amount of cut grass is spilling out from under deck, the tube may be plugged or the bags may be full— discontinue mowing, stop the mower, disengage the PTO and then empty the catcher or clear the tube.

● **WARNING**

ALWAYS shut off the mower. Disengage the PTO, and allow all moving parts to stop BEFORE disconnecting or clearing tube, or emptying catcher.

Before leaving the operator's position for any reason, engage the parking brake, disengage the PTO, stop the engine and remove the key.

To reduce fire hazard, keep the engine, rider and mower free of grass, leaves and excess grease. Do not stop or park rider over dry leaves, grass or combustible materials.

AFTER OPERATION

Remove any debris from the screen on the under- side of the lid. *Note: The lid screen can be removed for easier cleaning and should be cleaned regularly.*

The blower housing and tube should be removed for cleaning.

Inspect the grass bags for wear or damage. Make sure that there is a snug fit between mower deck, blower housing, tubes, and grass catcher cover.

STORING THE GRASS CATCHER

Clean the grass catcher thoroughly using a mild detergent (other products may damage the tube). Remove any debris from the screen on the underside of the lid. The screen can be removed for easier cleaning.

If paint has been scratched on metal parts, touch up with paint, or apply a thin film of oil to prevent corrosion.

Store in a dry area. Hang the catcher and catcher bags to dry thoroughly before storing for a long period of time.

Always store away from moisture.

MOWING WITHOUT THE BLOWER

For operation without the blower, the discharge chute must be properly installed.



WARRANTY

OWNER/OPERATOR'S RESPONSIBILITY

It is the owner and/or operator's responsibility to read the owner's manual before use. Failure to read the owner's manual is considered a misuse of this equipment.

It is the owner and/or operator's responsibility to inspect the product and to have any part(s) repaired or replaced before continued operation. Failure to do so could cause damage, excessive wear to other parts, or jeopardize operator safety.

LIMITED WARRANTY

Bad Boy Mowers warrants to the original purchaser of any new Bad Boy Mower Accessory that the equipment be free from defects in material and workmanship for a period of **90 days** from date of retail sale. At Bad Boy Mowers request, the customer will make the defective part available for inspection by Bad Boy Mowers and/or return the defective part to Bad Boy Mowers. Transportation charges prepaid.

WHAT THIS WARRANTY DOES NOT COVER:

This warranty does not cover defects caused by depreciation or damage caused by wear, accidents, improper maintenance, improper use or abuse of the product, alterations, or failure to follow the instruction contained in the Owner's Manual for operation and maintenance.

Normal maintenance service and normal replacement items such as Belts, Pulleys or normal deterioration of exterior finish due to use or exposure.

Bad Boy Mowers will not be responsible for the pickup and delivery of a machine for warranty purposes or inspection.



WARRANTY LIMITATION:

THERE IS NO OTHER EXPRESSED WARRANTY. ANY WARRANTY THAT MAY BE IMPLIED FROM THIS PURCHASE INCLUDING MERCHANTABILITY AND FITNESS FOR A PARTICULAR PURPOSE IS HEREBY LIMITED TO THE DURATION OF THIS WARRANTY AND TO THE EXTENT PERMITTED BY

LAW ANY AND ALL IMPLIED WARRANTIES ARE EXCLUDED. Some states do not allow limitations on how long an implied warranty lasts, so the above limitations may not apply to you.

BAD BOY MOWERS WILL NOT BE LIABLE FOR ANY INCIDENTAL, CONSEQUENTIAL, OR SPECIAL DAMAGES AND/OR EXPENSES IN CONNECTION WITH THE PURCHASE OR USE OF THE UNIT.

Some states do not allow the exclusion or limitation of incidental or consequential damages, so the above limitation(s) or exclusion(s) may not apply to you.

HOW TO OBTAIN SERVICE UNDER THIS WARRANTY:

Warranty service can be arranged by contacting the dealer where you purchased the mower or by contacting Bad Boy Mowers at warranty@badboymowers.com.

Proof of the date of purchase may be required to verify warranty coverage

INSTALLATION INSTRUCTIONS: Bad Boy Grass Bagging System



STEP 1: Install the Bag Carrier.

NOTE: The models depicted may not be your specific model. Unless otherwise noted, the procedure will be the same regardless of the model.

- Locate the carriage bolts to be used in this portion of the installation. Remove the bolts and replace them with the provided 3/8 x 1" GR8 carriage bolts and nuts. **Figure 1a** is for all MZ and ZT models. **Figure 1b** is for the Maverick.
- Set the Carrier Supports in place. Align the corresponding holes from figure 1a and secure the brackets using the previously removed nuts and bolts (**figure 1c**). Leave the bolts just "snug" in case further adjustment is needed. Install the Carrier mount as shown in. Align the corresponding holes and secure it using the provided 1/2 x 1" bolts and locking nuts.
- Install the Rear Receiver according to the instructions (**figure 1d**).

NOTE: The receiver (included in this package) is normally a separately sold item and has its own set of instructions regardless of Model (MZ, ZT, or Maverick).

- Install the Center Support into the receiver (**figure 1e**).
- Install the Carrier mount with the wider portion of the offset to the right of the machine as shown in (**figure 1f**). Align the corresponding holes and secure it using the provided 1/2" locking nuts and the 1/2 x 2 1/2 bolt and locking nuts.
- Install the Carrier Assembly onto the Carrier Mount by sliding the receivers over the tubes and aligning the corresponding holes (**figure 1g**). Secure the Carrier using the provided 1/2 x 2 1/2" bolts and locking nuts.
- Install the Carrier Manifold by aligning the corresponding holes and secure using the provided 1/2 x 3/4 bolts and locking nuts. The tube should be pointing out and to the side as indicated in **figure 1h**.
- Spread the Canvas Cover over the Carrier and align and snap in place (**figure 1i**). Clip the edges to the frame on the side and the rest of the way around (**figure 1j, 1k**).

NOTE: Some carriers may have canvas already attached, if so, proceed to next step.

- Slide the bags in place (**figure 1m**).
- If installing the deflector (optional), use the outside bolts from the Carrier Manifold, attach the deflector as shown (**figure 1n**) and re-install the bolts and nuts.



1a



1b



1c (Maverick)



1c (MZ and ZT)

INSTALLATION INSTRUCTIONS: Bad Boy Grass Bagging System



1d



1e

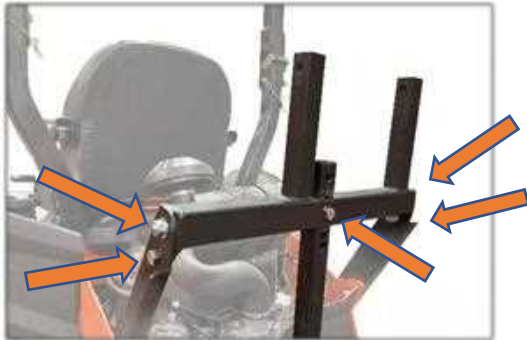

1f

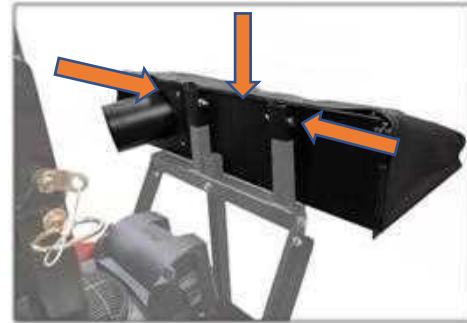

1g

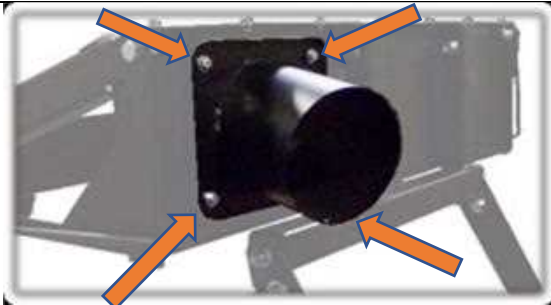

1h



1i



1j



1k

INSTALLATION INSTRUCTIONS: Bad Boy Grass Bagging System

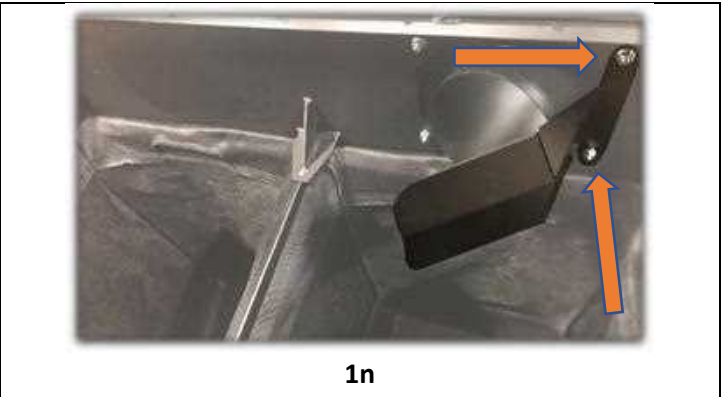
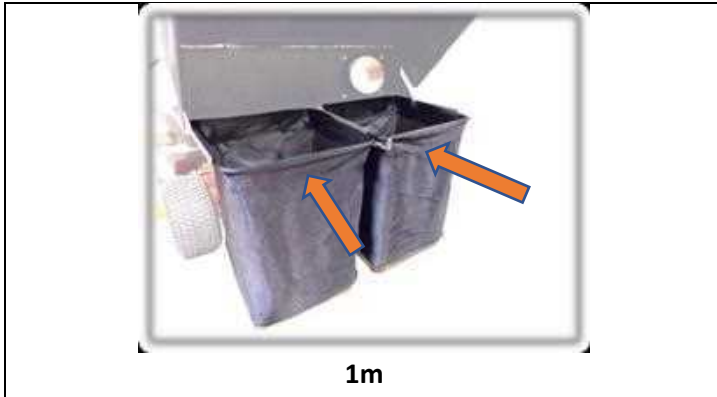

STEP 2: Install the Blower.

NOTE: The models depicted may not be your specific model. Unless otherwise noted, the procedure will be the same regardless of the model.

- Remove the rubber chute and the pulley cover (Figure 2a). Retain the nuts and bolts to be re-used.
- Use the nuts and bolts previously removed to secure the Blower Mounting Bracket to the deck (Figure 2b).
- Remove and retain the bolt holding the outside pulley indicated (figure 2c).
- Set the Pulley in place exactly as shown and return the bolt and washers previously removed (figure 2d). MZ models will need a spacer (provided) in between pulleys to assist in belt alignment.
- For **MZ, ZT, and Maverick** models **only**, add the Block Out Plate to the top inner edge of the blower using the provided $\frac{1}{4}$ -20 x $\frac{3}{4}$ bolts and nuts and the tensioner spring bolt indicated (figure 2e).
- Attach the Blower to the Blower Mounting Bracket by aligning the corresponding holes and inserting the retaining pin through both sets of holes. Secure the retaining pin with the hairpin (figure 2f).

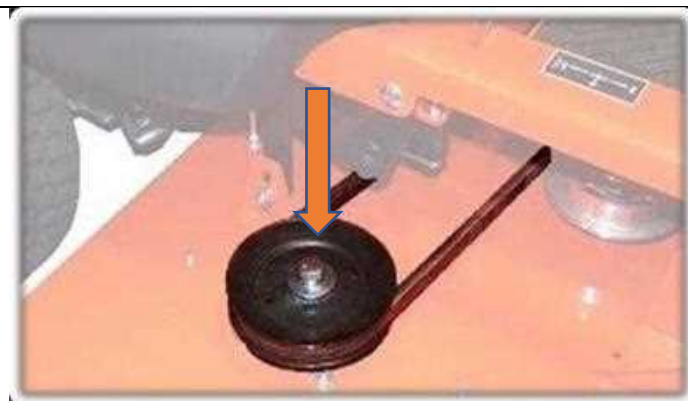
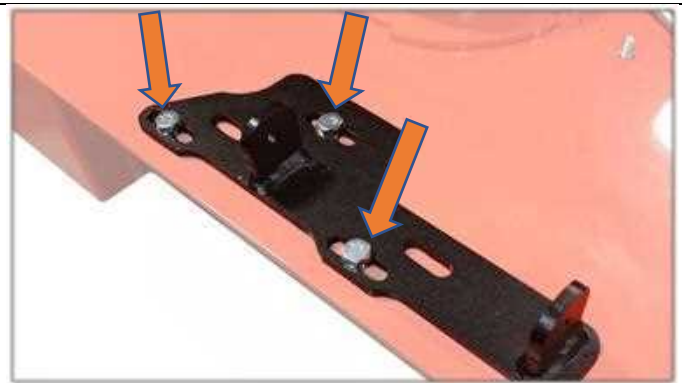

INSTALLATION INSTRUCTIONS: Bad Boy Grass Bagging System

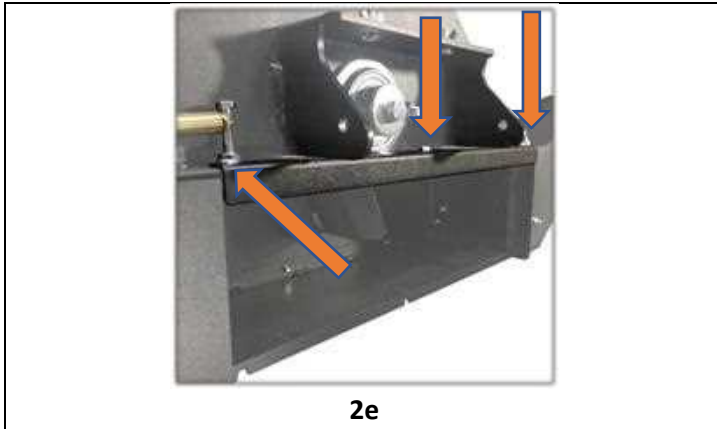

STEP 3: Belt Routing and Installing the Covers

NOTE: The models depicted may not be your specific model. Unless otherwise noted, the procedure will be the same regardless of the model.

- Pull the belt through the pulley bracket and loop it around the blower pulley (figure 3a). It is helpful to compress the tensioner pulley while pulling the belt through the bracket.
- Loop the remaining end around the deck pulley (figure 3b) previously installed in Step 2. **NOTE:** The portion of the belt from the top pulley will be installed toward the back of the machine. Routing the belt in the opposite direction will cause the blower to not function properly.
- Install the outside cover using the provided xxx tech screws (figure 3c).
- Install the pulley cover using the provided 1/4-20 x 3/4 carriage bolts and wing nuts (figure 3d).

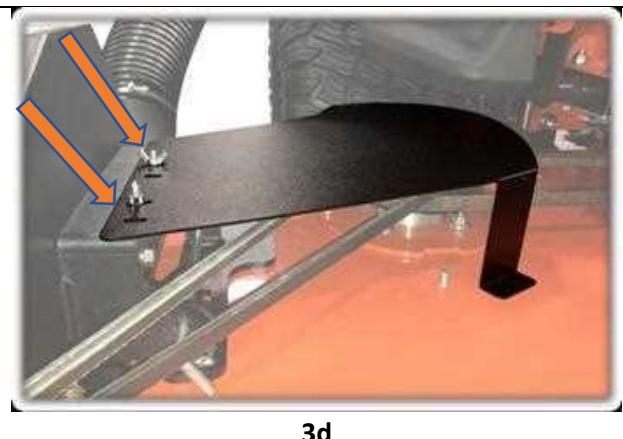
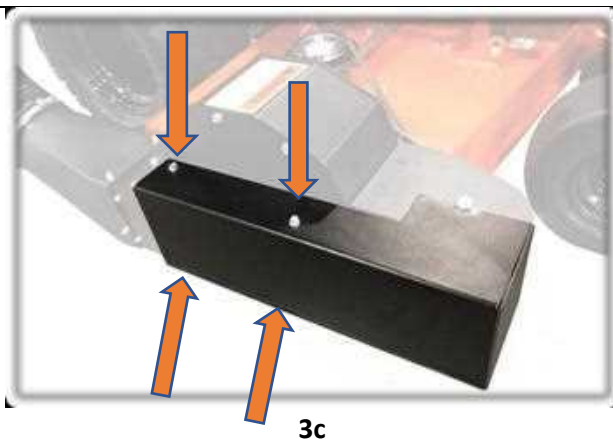
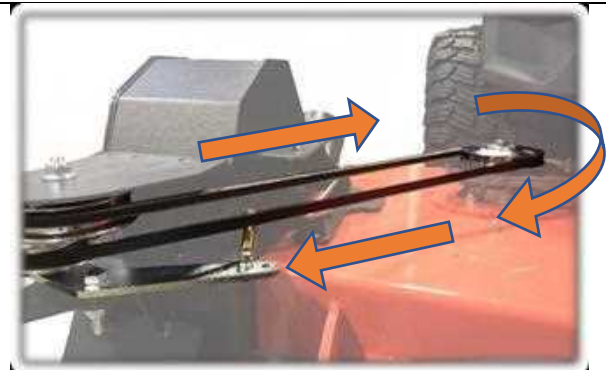
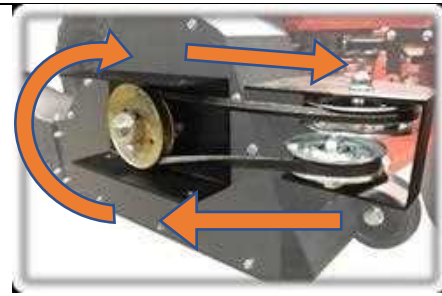

INSTALLATION INSTRUCTIONS: Bad Boy Grass Bagging System



STEP 4: Install the Trunk Hose and Counter Weights

- Attach the hose to the hose tube and secure it with the provided hose clamp (figure 4a).

NOTE: It may be helpful to use a lubricant to assist the step (i.e. dish soap).

- **NOTE:** On some models, the Hose will need to be trimmed. To Trim the hose, hold it up to the Blower and mark the length to be cut. There should be no dipping, sagging or kinking of the hose. Also, the hose should not rub the tire (figure 4b). Trim the hose using a knife and cutters (to cut the plastic coil).
- Attach the hose to the blower to the blower using the provided hose clamp. **The hose should be installed in a manner that it does not sag or make a hard turn. The hose should sweep up to the bagger as shown in figure 4c.**

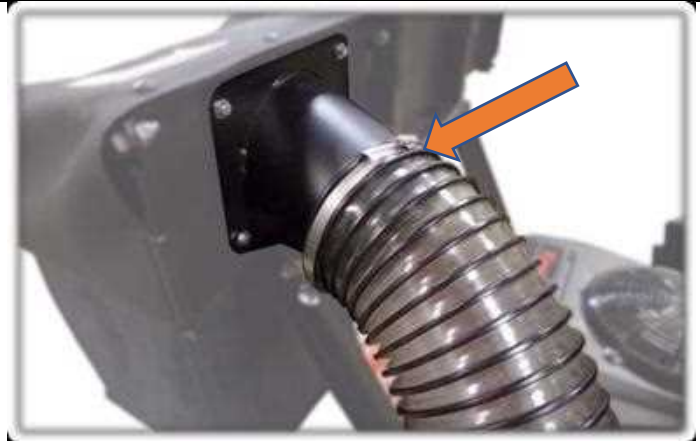

4a



4b



4c

STEP 5: Install the Counter Weights. Installations to be made according to model and/or deck size, using the provided hardware for each individual model

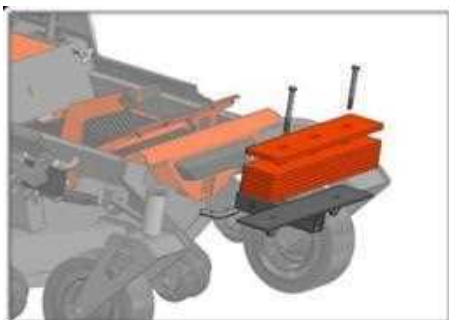

Set-up for all R-series, Maverick, 2021 and newer ZT models.

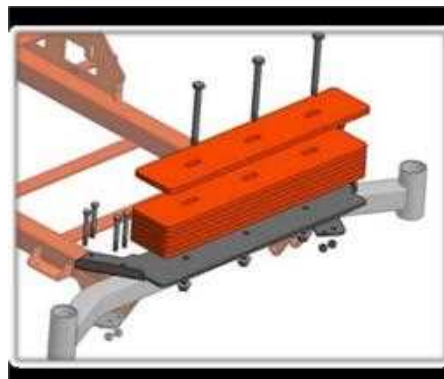

Set-up for All MZ (any year model) and ZT models up to 2020.

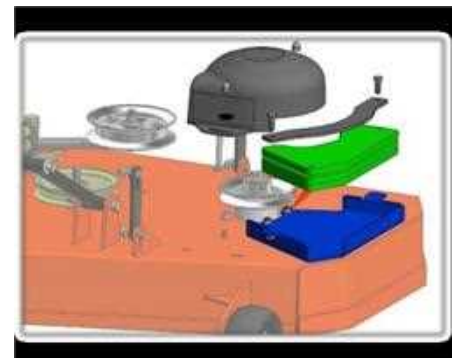

Set-up for all MZ, ZT, and Maverick models with 54" & 48" decks only.